

Original Research Paper

A Simulation Study of Enhanced Distillation Using Ultrasound Waves for the Separation of Azeotropic Mixtures

^{1,2}Taha Mahdi and ³Ammar Emad Al-Kawaz

¹Midland Refineries Company, Ministry of Oil, Daura, Baghdad, Iraq

²Chemical Engineering, University of Babylon, Iraq

³Polymer and Petrochemical Industry, College of Material, University of Babylon, Iraq

Article history

Received: 7-12-2017

Revised: 20-12-2017

Accepted: 27-12-2017

Corresponding Author:

Taha Mahdi

Chemical Engineering,

University of Babylon,

Babylon, Iraq

Email: tahamahdi9@gmail.com

Abstract: The potential of ultrasound waves to enhance distillation system for azeotropic mixture is examined through process flowsheeting using Aspen Plus. Since sonication is not a standard feature in the software library, a mathematical model of the proposed distillation system is developed based on first principles in Aspen Custom Modeler and later exported to Aspen Plus environment for process simulation and design studies. Ethyl acetate and ethanol mixture is used as a case study, with a target of producing 99% pure top product from a feed containing 65% ethyl acetate. Sensitivity analyses are carried out to examine the influence of various design and operating variables of the top product's purity and heat duties. When compared to extractive distillation, the proposed ultrasonic distillation process offers a 14.6% savings of operation costs. The proposed distillation system has also been tested for other azeotropic mixtures with similar success.

Keywords: Process Intensification, Sonication, Azeotropic Mixture, Aspen Custom Modeler, Aspen Plus

Introduction

Separation of azeotropic mixtures is known to be challenging and many alternatives have been introduced including conventional and emerging processes such as extractive distillation azeotropic distillation, pressure swing distillation, pervaporation and dividing-wall distillation column (Mahdi *et al.*, 2015a; Alkudhiri *et al.*, 2012; Liang *et al.*, 2017). While some of these processes have been in commercial use, there is a need to develop new processes with more attractive capital and operating cost requirements since distillation is widely used in the process industry and consuming large amount of energy. One way of realizing this is by exploiting some peculiar physical and chemical phenomena within existing processes to provide higher efficiency and equipment size reduction. This sets the premise for the development of emerging processes under the theme of process intensification.

One way of applying this approach is to exploit sonochemistry in enhancing the process performance. In addition to the widespread application of ultrasound in facilitating cleaning processes, its application can also be found in reaction systems such as biodiesel production

(Chen *et al.*, 2014), ethanol fermentation (Sulaiman *et al.*, 2011) and separation system such as adsorption (Bono *et al.*, 2008). Its application to distillation process is however still limited. Nii *et al.* (2006) have examined the use of ultrasonic atomizer to disperse ethanol solution into air streams and concluded that better energy saving processes can be established compared to normal distillation. In another perspective, sonication has also been shown to positively impact the Vapor-Liquid Equilibrium (VLE) of azeotropic mixtures (Ripin *et al.*, 2009). Similar trends are also obtained on other compounds including ethanol-ethyl acetate mixture (Mahdi *et al.*, 2014). Inspired by these results, a mathematical model of a single stage VLE system has been derived and validated (Mahdi *et al.*, 2015b) and based on this model, the design of an ultrasonically intensified distillation system based is proposed and elaborated in this study.

Mechanism of Ultrasonic Separation

Acoustic cavitation is a phenomenon by which ultrasonic waves induce bubbles formation, growth and collapse (Apfel, 1997). The collapse normally takes

place when the bubble reaches critical size referred to as the resonance size. Depending on the operating condition, the growth-collapse process may end up in two possible scenarios. Firstly, if they are smaller than the resonance size, bubbles tend to migrate from the minimum pressure, also known as pressure node to the maximum pressure referred to as antinode. This is driven by primary Bjerknes forces and will lead to a condition whereby bubbles are collapsing inside the liquid and generating high temperature (Ashokkumar *et al.*, 2007). This causes the formation of radicals and highly reactive intermediates within the bubbles during the collapse. For this reason, they are called “active” cavitation bubbles. This condition facilitates various chemical pathways, thus enhancing sonochemical reactions (Ashokkumar and Mason, 2007). Recently, numerous papers have reported enhancement effect of ultrasound on biodiesel synthesis with basic strength of catalyst (Parkar *et al.*, 2012; Choudhury *et al.*, 2014). They established the mechanism of this enhancement by discrimination of the physical and chemical effects of cavitation bubbles in the system on transesterification of oil with alcohol using a catalyst.

Secondly, if they are larger than the resonance size, they will be forced to the node to become “inactive”. These bubbles eventually float out of the liquid due to buoyancy forces and collapse at the liquid surface (Louisnard and González-García, 2011). Similar observation is reported in a study involving ethanol/water mixture, where the bubble travel through the liquid mixture and collapse in the fountain jet formed at the liquid surface releasing the alcohol vapor in the bubble (Suzuki *et al.*, 2012). These phenomena have significant impact on mechanical and physical processes such as cleaning and vapor-liquid separation processes

Based on the above arguments, the system is considered “inactive” at low frequency, high temperature and hydrocarbons are involved (Mahdi *et al.*, 2015b). It is also important to note that the ultrasonic wave generates micro-point vacuum condition within the liquid during bubbles formation. In this condition, azeotrope of the vapor components inside the bubbles is altered, resulting in changes in vapor liquid equilibrium. This is confirmed by a various studies that proved the breaking of azeotrope under vacuum pressure condition (Kamihara *et al.*, 2008; Wisniak *et al.*, 2001). To understanding the mechanism of the enhancement separation of the system in this process, these bubbles eventually float out of the liquid due to buoyancy forces and collapse at the liquid surface in the fountain jet releasing the vapor in the bubble to the vapor phase. Thus, the mole fractions of the vapor inside the bubbles are considering equal to those in

the vapor phase. These are the scenarios considered in this study.

Mathematical Modeling

The schematic diagram of the distillation system is shown in Fig. 1. Using conservation principles and thermodynamic equilibrium as the central principles, a mathematical model of the system is derived. In this process, a feed with a molar flow rate F and composition x_f is separated into a lighter top product D and a heavier bottom product B with compositions x_d and x_b , respectively. Sonication is introduced at each separation stage and each separation stage is assumed to be in phase equilibrium. The model follows a stage-to-stage calculation with a top-down numbering approach for the stages (i.e., the first stage is the condenser).

Material and Energy Balances

To illustrate the mathematical modeling for the material and energy balance of the column as shown in Fig. 1, the distillation column is separated into five parts that are explained in the following subsections: Condenser, reboiler, feed stage, rectifying and stripping.

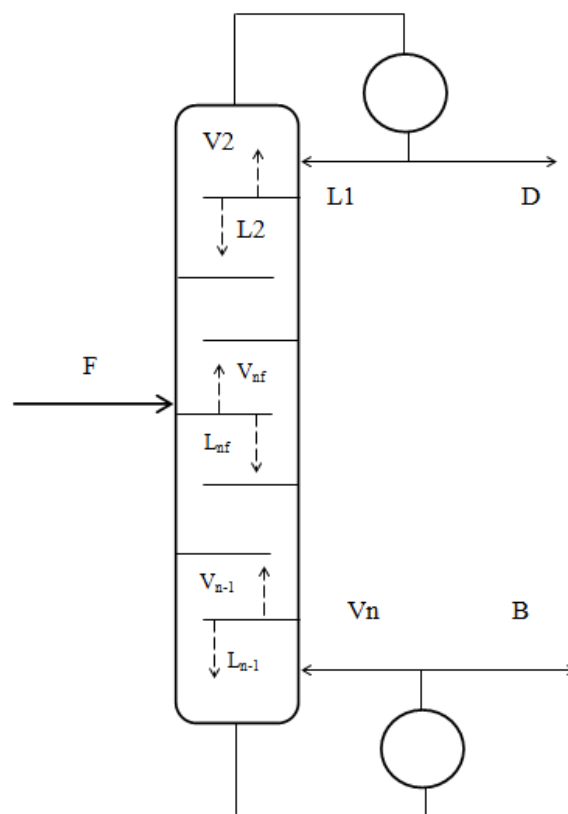

Fig. 1: Schematic diagram of the ultrasonic distillation process

Maintaining the Integrity of the Specifications

The template is used to format your paper and style the text. All margins, column widths, line spaces and text fonts are prescribed; please do not alter them. Your paper is one part of the entire proceedings, not an independent document. Please do not revise any of the current designations.

Condenser, Reboiler and Feed Stage

The condenser accepts the vapor rising from the top stage and removes a significant amount of heat to produce liquid that is collected in the distillate drum. In this study, total condensation is assumed. For this subsystem, the overall material and heat balance equations are similar manner to a condenser, reboiler and Feed Stage of ordinary distillation column.

Rectifying and Stripping Stages

Apart from the specified feed stage, condenser and reboiler, all other stages can be represented by generic balance equations for the i th stage. A mathematical model of total material and component balance for the ultrasonic distillation is essentially similar to ordinary distillation column. In the rectifying section, ultrasonic waves are introduced to the liquid accumulated on the tray. The energy balance equation can be written as follows:

$$L_{i-1} * h_{L(i-1)} + V_{i+1} * h_{V(i+1)} = L_i * h_{L_i} + V_i * h_{V_i} + q_U \quad (1)$$

Here, $i + 1$ refers to the stage below the i th stage, $i - 1$ refers to the stage above the i th stage, h_v and h_L are enthalpies of the vapor and liquid phases, respectively and q_U is the ultrasonic energy that is provided to the stage by a transducer. It is represented by the ratio of ultrasound intensity (I) to the sound of speed in a liquid medium (c), as shown in Equation 2:

$$q_U = \frac{I}{c} \quad (2)$$

The stripping section has the design of an ordinary distillation column and the energy balance equation can be represented by:

$$L_{i-1} * h_{L(i-1)} + V_{i+1} * h_{V(i+1)} = L_i * h_{L_i} + V_i * h_{V_i} \quad (3)$$

Thermodynamic Equilibrium

Sonication is a fast process with intermittent spikes of energy appearing on the order of microseconds. It also produces ultrasonic waves that generate micro-point vacuum conditions within the liquid during bubble

formation. Because these phenomena happen very fast, the net temperature changes to the bulk liquid are minimal. It is therefore reasonable to assume that vapor-liquid equilibrium can take place in a similar manner to normal separation processes. Treating the components in the liquid phase as a non-ideal mixture and the components in the vapor phase are treated as an ideal mixture with a fugacity coefficient equal to unity. The resulting equilibrium relationship yields the modified Raoult's law:

$$P * y_i = \gamma_i * p_i^* * x_i \quad (4)$$

Sonochemistry

The central theme of this innovation is based on the proposition that the rapid phenomena of generation, expansion, compression and collapse of micro-bubbles as a result of sonication alter the thermodynamic property of the liquid to the extent that it positively shifted the azeotrope point. At the limit, an azeotrope is eliminated and high purity separation is made possible via distillation. It is also assumed that the equilibrium takes place when the bubble is at its maximum size prior to collapse. By calculating the molar composition of the vapor components inside the bubble y_i at this condition and with the physical properties of the liquid, the liquid composition can be computed using Equation 4, thus defining the VLE conditions. Details of this model are explained elsewhere (Mahdi *et al.*, 2015b) and only a summary is provided here.

The molar composition in the vapor phase is computed based on the condition at the maximum bubble size prior to collapse, at bubble radius R_{max} . The molar composition of component i is given by:

$$y_i = \frac{n_i}{N} \quad (5)$$

Here, n_i is the total number of component i and N is the total number of all components inside the bubble. The number of moles of component i can be estimated from the ideal gas relationships as follows:

$$n_i = \frac{4\pi P_i R_{max}^3}{3\Re T} \quad (6)$$

Here, P_i is the partial pressure of component i , T is the temperature inside the bubble, \Re is the ideal gas constant and R_{max} is the maximum bubble radius that can be determined from the Rayleigh-Plesset equation and is influenced by the ultrasonic frequency and intensity.

Ultrasonic Distillation Design

Case Study: Ethanol-Ethyl Acetate

As a case study, Ethanol/Ethyl Acetate (ETOH/ETAC) separation process is chosen. Ethyl Acetate (ETAC) is an important solvent that is used in a wide range of applications in the industry and is commonly produced by Esterification of ethanol (ETOH) with acetic acid. It is assumed that the feed to the proposed distillation system is supplied from a reactor in a typical ETAC manufacturing facility with a product composition containing 65% ETAC at 333.15 K and 1 bar (20). Unfortunately, a mixture of ETAC and ETOH is known to form an azeotrope at 55 mole% of ETAC at a minimum boiling point of 71.8°C, thus making the product purification process very challenging.

Process Simulation

The proposed distillation system, herein called Ultrasonic Distillation (UD), is similar to an ordinary distillation column except for the addition of an ultrasonic transducer in the equilibrium stages. For flexibility, the location of these stages depends on the feed composition because it is intended that the sonication stages start from the feed stage to the top column (rectifying section), while the stages of the stripping section do not have a transducer. Simulation studies on the proposed design based on the mathematical model described above are carried out in an Aspen Custom Modeler (ACM) flowsheeting environment.

A fresh feed stream containing 65 mol% ETAC and 35 mol% ETOH at a flow rate of 100 kmol/h is fed into the bottom of the column because it is above the azeotrope point of 0.55 mol% ETAC. The operating conditions of the ultrasound transducer are based on the optimum operation conditions obtained from previous works 7, 8, which include the settings of 500 W/cm² ultrasound intensity and 25 kHz frequency. The reflux ratio and number of stages used are 8 and 35, respectively. According to these operating conditions, the bottom composition is rich with ETOH, while the purity of products at the distillate stream contains 99 mol% ETAC. The NRTL equation is used to compute the activity coefficients of the liquid phase because it is recommended for liquid-liquid systems containing an alcohol and non-polar hydrocarbon liquids such as ETAC (Kirpalani and Toll, 2002). For the vapor phase, ideal gas behavior is assumed.

Separation Potentials

Sensitivity analyses are carried out to study the effect of the distillation design parameters on the

quality of separation achieved. This is to verify the adequacy of the design parameters to establish the targeted separation quality.

Effect of the Number of Theoretical Stages

The number of theoretical stages sets the size of the column. More stages reflect a taller column and more opportunity for contacts between components, thus increasing the achievable separation. This is illustrated in Fig. 2 where the potentials plateaued when 35 trays are used. At this value, the targeted 99% ETAC purity in the distillate is achievable.

Effect of Feed Stage Location

Figure 3 highlights that a feed stage has linear effects on the achievable purity if the feed location is moved above stage 8 to about stage 13 before the sensitivity is reduced. The result also affirmed the choice of stage 17 as the feed location to provide the intended separation quality.

Effect of Reflux Ratio

The effect of the reflux ratio on ETAC composition is consistent with that of normal distillation. Figure 4 shows the upward trend of the distillate composition of ETAC with increasing reflux ratio. The desired purity of 99.0 mol% ETAC is achieved when the reflux ratio is set to 8. A rising reflux ratio increased the liquid flow in the column and resulted in more opportunity for contacts between vapor and liquid phases.

Effect of Ultrasonic Intensity and Frequency

A salient feature of the proposed ultrasonic distillation system is the use of ultrasonic transducers on the equilibrium stages of the rectifying sections, which adds two additional variables, namely ultrasonic intensity and frequency, to the process operations. Following a recommendation from the previous experimental work 9 with a frequency fixed at 25 kHz, the effect of ultrasonic intensity on ETAC purity is shown in Figure 5. It is noted that increasing the intensity provides a positive impact on the achievable product purity and a 99 mole% ETAC in the distillate stream is established when the intensity is 500 W/cm². Above this value, the sensitivity significantly declines to finally reach a plateau.

As previously explained (Mahdi *et al.*, 2015b), ultrasonic intensity impacts the process by varying the bubble populations in the liquid medium. By producing more micro-bubbles along with the associated vacuum effects inside the liquid, the thermodynamics of the system are impacted to the extent that it alters the VLE of the system (Katikaneni and Cheryan, 2002), thus making the separation easier.

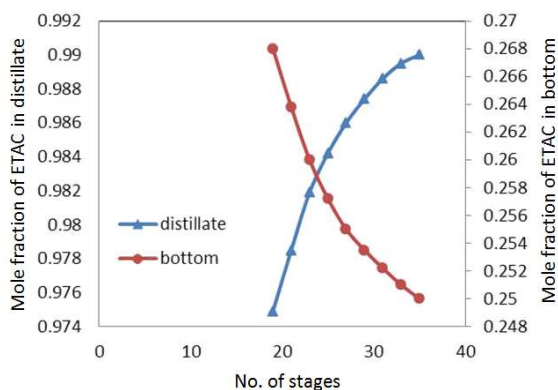

Fig. 2: Effect of the number of stages on ETAC purity in the distillate and bottom streams of the UD column

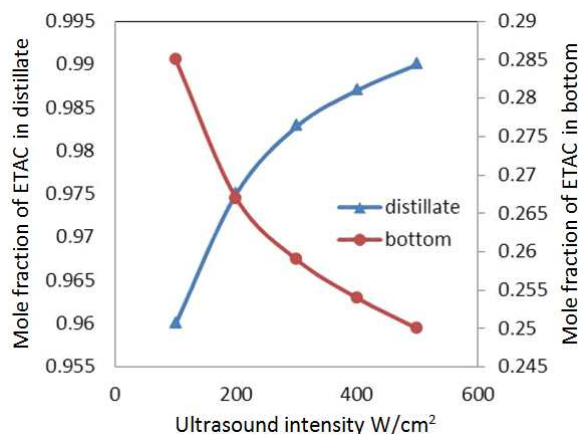

Fig. 5: Effect of ultrasonic intensity on ETAC purity in the distillate and bottom streams of the UD column

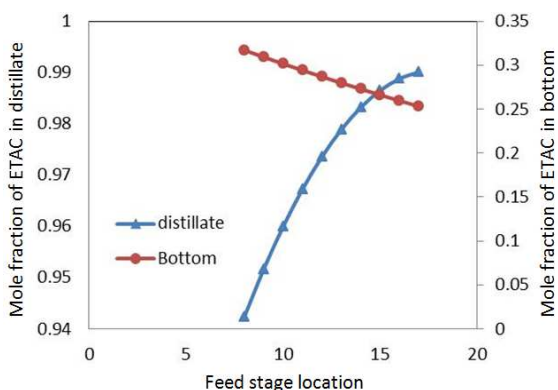

Fig. 3: Effect of feed stage location on ETAC purity in the distillate and bottom streams of the UD column

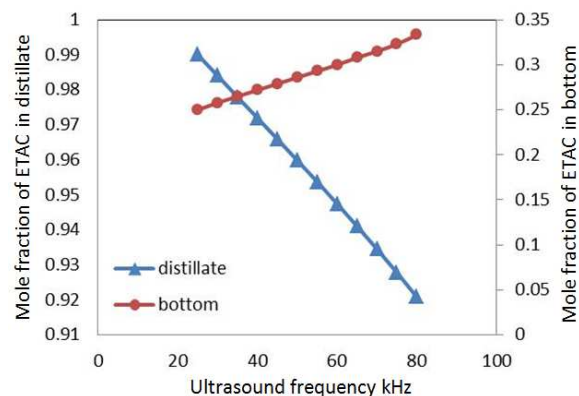

Fig. 6: Effect of ultrasound frequency on ETAC purity in the distillate of the UD column

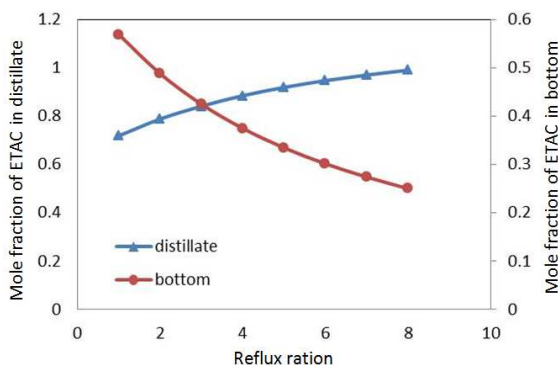

Fig. 4: Effect of reflux ratio on ETAC purity in the distillate of the UD column

The effect of the sonication frequency is shown in Fig. 6. Operating at a sonication intensity of 500 W/cm², an increase in frequency results in a negative effect in product purity. Note that the ultrasonic frequency affects the size of the bubbles formed; the bubble size increases with decreasing frequency. This facilitates mass transfer into the bubbles and their movements upward to collapse on the surface of the liquid, as desired by the vapor-liquid separation process.

Energy Requirements

The addition of an ultrasonic transducer provided advantages as previously discussed. It nevertheless adds an additional energy requirement, electricity. It is therefore important to observe the sensitivity of the proposed design on the overall heat duties of the system. There are three major components of heat duties in the operation of the proposed column, i.e., condenser (Q_C), reboiler (Q_B) and ultrasonic related energy (q_U). The total ultrasonic energy, Q_U , is calculated by multiplying the energy requirement of each transducer given in Equation 7 with the number of transducers used in the system (N_{trans}):

$$Q_U = q_U * N_{trans}. \quad (7)$$

Because the design parameters such as feed location and the number of stages are fixed based on the purity requirement, the assessment discussed here focused only on key operating conditions.

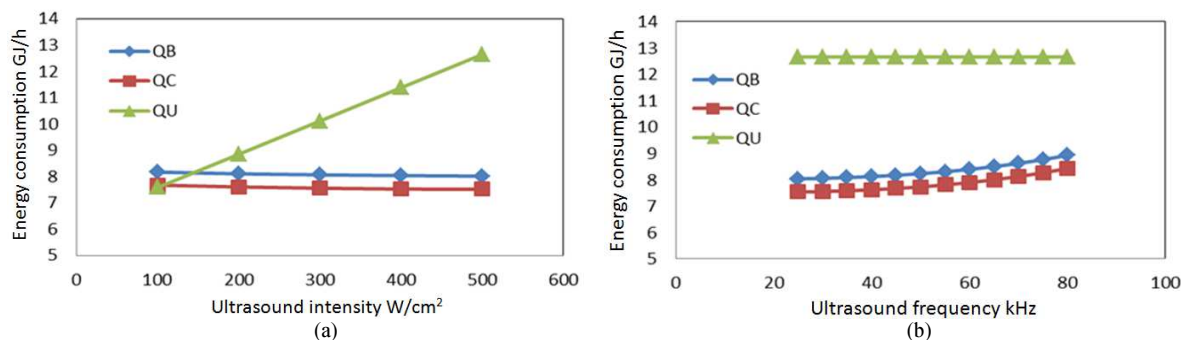

Fig. 7: Effect of ultrasonic intensity and frequency on condenser and reboiler heat duties of the UD column

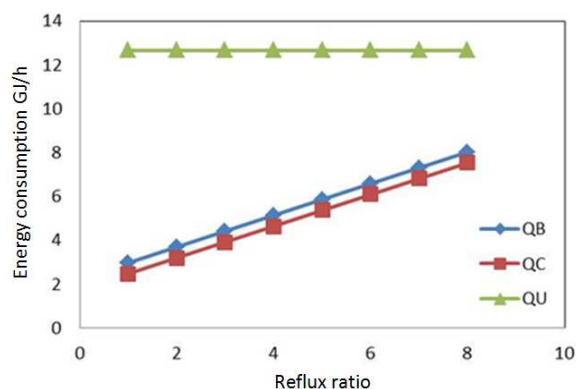

Fig. 8: Effect of reflux ratio on condenser and reboiler heat duties of the UD column

Effect of Ultrasonic Intensity and Frequency

Figure 7 shows that the condenser and reboiler duties are less sensitive to the changes in intensity and frequency. This is because the sonication phenomena have minimal impacts on the bulk temperature of a liquid medium (Merouan *et al.*, 2013). The energy requirement to power the sonication device is also not affected by the frequency setting but is strongly influenced by the intensity. This is clearly shown in Fig. 7a, where increasing the operational frequency demands higher electrical energy.

Effect of Reflux Ratio

The reflux ratio has a similar influence on the QC and QB as in a normal distillation and is irrelevant to the QU. Increasing the reflux ratio introduces more liquid into the column, thus increasing the energy consumption of the condenser and reboiler heat duties as shown in Fig. 8.

Optimal Design

The sensitivity analyses provided the response of key performance characteristics towards the design specifications and operating conditions. Based on these insights, the column is optimized to determine the optimum settings based on six design variables, aiming at maximizing the ETAC purity in the distillate.

Table 1: Optimum design parameters at ETAC purity of 99.9 mol% for the UD column

Parameters	Values
No. of trays	41.00
Feed stage locations	27.00
Reflux ratio	9.18
Bottom flowrate kmol/hr	42.23
Intensity W/cm ²	617.00
Frequency kHz	21.40

The variables are the ultrasound intensity and frequency, number of trays, feed stage locations, reflux ratio and bottom flow rate. This is carried out with fixed feed conditions (flow rate, temperature and compositions) and column pressure. The optimization is carried out using a successive quadratic programming algorithm, known as FeasOpt optimization method available as part of the ACM simulator library is used. Feasible Optimization (FeasOpt) is a feasible path successive quadratic programming optimizer. It can be used for optimization or maximum log likelihood estimation. FeasOpt evaluates the objective variable at the current point and moves the design variables, initial and control variables (in the case of optimization) or estimated variables (in the case of estimation) to take the objective variable towards its optimum value. After solving with the new values of the design, initial and control variables or estimated variables, FeasOpt re-evaluates the objective variable. In this way, FeasOpt steps towards the optimum solution, more details can be found in the Aspen Tech (Chang *et al.*, 2012). The optimization results of the UD process are summarized in Table 1.

Generalization of the Proposed Design

Although the study focused on the ETAC/ETOH mixture, the proposed design can also be extended to other mixtures. As an illustration, a few selected azeotropic mixtures with different relative volatilities are

examined. Azeotropes are formed at 89.4 mol% ethanol at 78.1°C for an ethanol-water mixture, 76.5 mole% of water at 92.4°C for an n-butanol/water mixture and 66 mol% methyl acetate at 53.5°C for a methyl acetate/methanol mixture.

Simulation Conditions

In all cases, the target product purity of 99 mol% in the distillate stream is set. The design parameters for the distillation system to be used for the various mixtures are fixed using a typical distillation design procedure and operating parameters such as reflux ratio, number of theoretical trays, feed tray location and bottom flowrate feed ratio and other specifications are fixed as shown in Table 2. The results obtained proved the capability of the proposed UD process in providing the intended separations for all of the mixtures. The largest number of stages, 37, is needed for the ETAC/ETOH system, while the 20 stages required for the n-Butanol-water system is the lowest number of stages required. The difference in the number of sonication stages required for

separating the binary azeotrope mixtures is influenced by the relative volatility of the systems, with the highest being the easiest.

The parameters of the sonication device are fixed at the preferred conditions with intensity at 500 W/cm² ultrasound and frequency at 25 kHz and a total flow of 100 kmol/h of saturated liquid at 25°C. Similarly, in all cases, an NRTL model is used for the liquid phase and ideal behavior is assumed for the vapor phase. For the purpose of comparison, feed compositions for all mixtures are fixed at 50 mol% of the light component. Note that because the purpose of this study is to illustrate only the potential of the proposed designs to be generalized for other mixtures, optimum operating conditions for each pair have not been determined.

Figure 9 shows the shift of the azeotropic point with an increasing number of stages in the rectifying section of the UD column. The results indicate that the proposed UD system is capable of overcoming azeotropes in all mixtures considered. The number of stages required corresponds to their relative volatilities.

Table 2: Operation conditions of a UD column for separation of the systems

Specifications of the UD column	Ethanol + Ethyl Acetate	Methyl acetate + Methanol	Ethanol + Water	n-Butanol + Water
Average Relative Volatility	1.15	1.6	2.9	3.1
Reflux ratio	8.00	5.0	3.5	2.0
No. of Stages Required	37.00	31.0	23.0	20.0
Feed tray location	24.00	19.0	14.0	11.0
Bottom flow rate	60.00	53.0	48.0	45.0

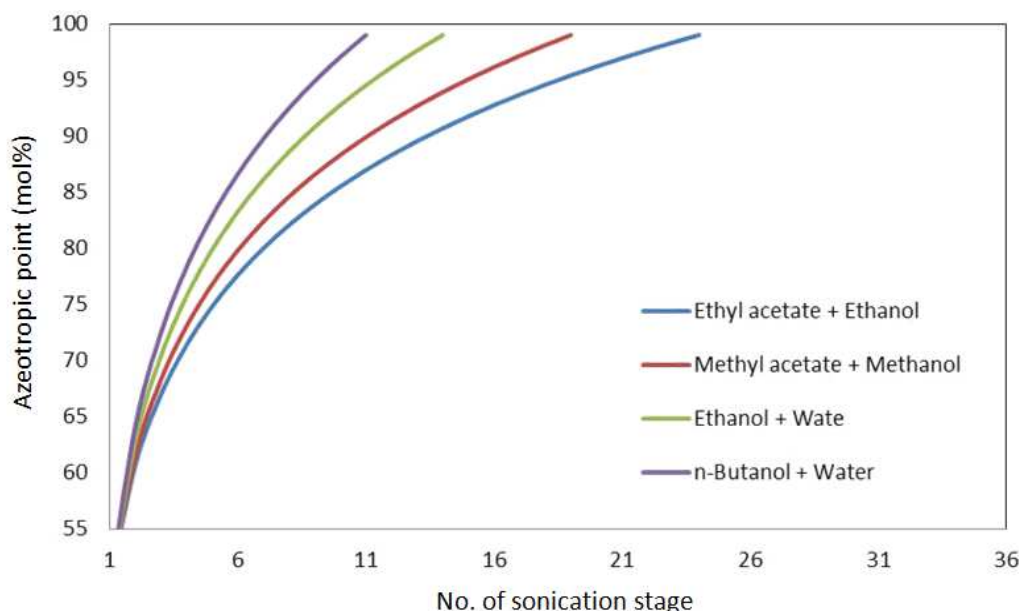

Fig. 9: Azeotropic point of a mixture related with number of sonication stages

Limitation: Maximum Boiling Point Azeotrope

All mixtures previously examined belong to a class of minimum boiling point azeotropes that prefer lower pressure conditions for ease of separation. This coincides with the phenomena in the UD system where the micro-point vacuum conditions introduced by the cavitation bubbles during sonication generate a lower operating pressure environment. This is, however, contrary to the requirement for the maximum boiling point azeotropic mixtures such as nitric acid/water and acetone/chloroform mixtures that prefer a high pressure operation to shift the azeotropic points downward (Ashokkumar *et al.*, 2007; Modla and Lang, 2008). This is an important limitation of the proposed ultrasonic distillation process.

Comparison of Ultrasonic Distillation with Extractive Distillation

Extractive Distillation Process

Extractive Distillation (ED) is a widely applied technology used to separate azeotropes and mixtures with relative volatilities of approximately 1.1 and below (Mahdi *et al.*, 2015a; Hosgor *et al.*, 2014). Because it is a common method used to separate azeotropic mixtures, it is interesting to compare the proposed ultrasonic distillation system to this process. As a case study, a homogeneous extractive distillation process to separate the ETAC/ETOH mixture is investigated and DMSO is selected as the entrainer because it offers a feed ratio of 1:1 and the highest relative volatility compared with other candidates as illustrated in Table 3 (Zhang *et al.*, 2012). Similar to the previous case, the feed flow rate is set at 100 kmol/h of saturated liquid at 25°C and NRTL is selected as the thermodynamic model. For the purpose of comparison, feed composition is assumed to be equimolar.

The schematic diagram of the homogeneous extractive distillation process is shown in Figure 10. It is a two-column system, one for extraction and another for solvent recovery. The extraction column has two feed streams, with the entrainer (S) fed at a location higher than the original mixture because it has a higher boiling point. Pure ETAC is collected as the top distillate product of the first Distillation Column (DC1), while the bottom product contains a mixture of DMSO and ETOH is fed to the second Distillation Column (DC2). A high purity ETOH by-product and DMSO are obtained as the top distillate and bottom product of DC2, respectively. DMSO that is recovered is recycled back to the DC1. Table 4 presents the main design parameters for the extractive distillation process.

Table 3: Extractive distillation agents recommended for separating an ETAC/ETOH mixture

Entrainers	Ratio	Relative volatility
dimethyl sulfoxide (DMSO)	1:1	1.859
N,N-dimethylacetamide (DMAC)	1:1	1.707
N,N-dimethylformamide (DMF)	1:1	1.407
N-methyl-2-pyrrolidone (NMP)	1:1	1.341

Table 4: Design parameters of a two-column extractive distillation sequence

Design parameters	Unit	Value
Reflux ratio DC1	Kmol/Kmol	2
Number of stages DC1	-	35
Feed stage of entrainer	-	5
Feed stage DC1	-	24
Reflux ratio DC2	Kmol/Kmol	1
Number of stages DC2	-	27
Feed stage DC2	-	15
Feed flowrate of ETAC	Kmol/hr	50
Feed flowrate of ETOH	Kmol/hr	50
Feed flowrate of entrainer	Kmol/hr	100
ETAC recovery	mol%	99
ETOH recovery	mol%	97

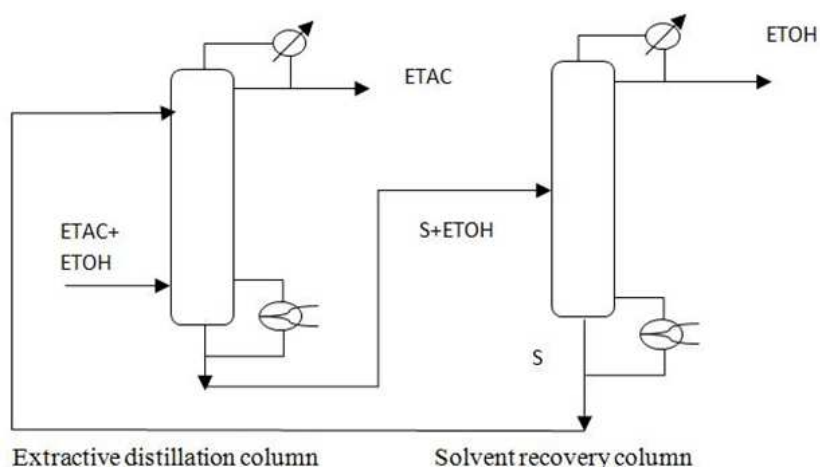

Fig. 10: Schematic diagram of the extractive distillation process, where S is a solvent (entrainer) component

Comparison of Energy Consumption

Table 5 presents a comparison of the energy consumption for the two distillation systems. Because the ED is a two-column system, it has two sets of reboilers and condensers. Although the UD has only one reboiler and condenser, it has 15 sonication devices in the rectifying sections and these devices consume electricity as a power source. The net result gives a lower energy requirement in terms of GJ/hour for the ED process to produce 99 mole% of ETAC. The total energy requirements for UD and ED technologies are 28.213 and 21.349 GJ/hr, respectively. However, this comparison does not correspond to the actual costs because the cost per joule of energy for the three energy consumption is not the same (Q_c , Q_B and Q_U).

Comparison of Operating Cost

The economic comparison between UD and ED processes will be same system which is ETAC/ETOH mixture and same operation conditions as considered in previous section. The investment cost of equipment for the both processes are not available involves the cost of trays, tower, heat exchangers (reboiler and condenser) and reflux drum, as well as transducer for UD process and also cost of the raw material is fixed. In this study the operating cost of utility was only considered which involves the cost of cooling water, steam and the electric consumption of sonication devices.

The goal of the economic comparison is to minimal separation costs for the processes while satisfying the product purity requirements. The operating cost (C_{ED}) for the ED process includes the costs of condensers (C_c) and reboilers (C_r) for the two columns, while in the case of the UD process, the operating cost (C_{UD}) as a result of the ultrasonic transducer (C_u) is added to the costs associated with the condenser and reboiler. These are represented by the following equations:

$$C_{ED} = \sum_1^2 (C_c + C_r) [\$ / h] \quad (8)$$

$$C_{UD} = C_c + C_r + C_u [\$ / h] \quad (9)$$

$$C_c = W_c * Q \quad (10)$$

$$C_r = S_r * Q_r \quad (11)$$

$$C_u = E_u * Q_u \quad (12)$$

Where:

Q_c (GJ/h) = The heat withdrew from a condenser of a distillation column

Q_r (GJ/h) = The heat added to a reboiler of a column

Q_u (GJ/h) = The heat power generated by ultrasound

W_c (\$/Mib) = the cost coefficients of cooling water used in a condenser for a column

S_r (\$/Mib) = The cost coefficients of steam used in a reboiler for a column

E_u (\$/kWh) = The cost of electric consumption of transducers

As a rough comparison, the utility pricing recommended from a chemical engineering design text book (Towler and Sinnott, 2013) is used. Using this cost structure, a low pressure steam of 6 bar and 160°C (S_r) needed for the reboiler is available at USD 4.03 per Mib. The cooling water costs include the cost of water at USD 2 per 1000 gal, pumping costs of between 1 and 2 kWh/1000 gal and a chemical treatment of about USD 0.02 per 1000 gal. Thus, the overall price of cooling water (S_c) is estimated to be USD 2.14 per 1000 gal. The electricity cost for the ultrasonic transducer (S_u) is fixed at USD 0.06 per kWh.

A detailed summary of the results for operation cost of both processes can be calculated by using Equations 8 to 12 as reported in Table 6. Note that in case of UD process, the operating cost of the transducers is approximately 22% of the total cost. Thus the utility cost of the transducers has not a great impact in increasing the operating cost. Since there is no secondary distillation column in the UD process, the operation cost of this process is more economical (savings of around 14.6%) when compared with the ED process. Using the values recommended in 26, which may be inaccurate in practice because the costs of utilities vary significantly depending on the plant location, the overall energy costs favor the UD.

Based on the results from Table 5 and 6, the comparison of the ED and UD does not conclude a distinct advantage for any of the systems in terms of total energy requirement. However, if the issue was to be examined from overall perspectives, the use of the UD would be more advantageous.

Table 5: Design parameters of a two-column extractive distillation sequence

Technique	Electric	DC1 column		DC2 column		Total (GJ/hr)
		QC	QB	QC	QB	
Ultrasonic Distillation (UD)	12.657	7.53	8.0	-	-	28.20
Extractive Distillation (ED)	-	6.26	8.8	2.7	3.6	21.35

Table 6: Operation cost of the configurations of the US process

Item	ED		UD	
	Operation cost (\$/h)	Cost Percentage %	Operation cost (\$/h)	Cost Percentage %
Condenser of column 1	62.5160	5.633	75.15	7.94
Reboiler of column 1	724.2429	65.258	661.70	69.81
Condenser of column 2	27.0340	2.435	–	–
Reboiler of column 2	296.0136	26.674	–	–
Electricity transducers	–	–	210.97	22.25
Total	1109.8000	100.000	947.82	100.00

In the ED, the use of entrainers introduces additional occupational hazards and the overall costs associated with maintenance and other costs associated with wastewater treatment and chemical disposal are expected to be higher. In addition, the UD system offers significant space savings and reduction of the capital costs of equipment such as the distillation column, pumps, vessels and heat exchangers because it is a single column system.

Safety Perspectives

One of the prime objectives of process intensification is to improve safety. It is one of the strategies in inherent safety design concept where reduction of the likelihood of failures is achieved because there is a reduction in the number of equipment components compared to alternatives such as extractive distillation. Intensification also facilitates the process by increasing the separation efficiency, thus resulting in smaller equipment. This can be clearly illustrated when the proposed UD is compared to the ED that is typically used in practice.

Moreover, since an ED process requires an additional chemical to serve as the entrainer, depending on the type of entrainer used, varieties of additional hazards are introduced to the process. For example, the DMSO entrainer used in the above comparison is a clear colorless liquid with a slight sulfurous odor, a specific gravity of 1.1008 and a melting point of 18.45°C. It is flammable with a flash point between 37.8 and 93.3°C. This chemical is toxic to blood, kidneys, liver, mucous membranes, skin and eyes. Its teratogenicity is not conclusive and therefore, it is not classified as such. DMSO is also easily absorbed through skin with the chronic effect of scaling dermatitis. Exposure to a high vapor concentration may include coughing, headache and shortness of breath.

This simplified hazard identification provides a clear advantage of not having DMSO as part of the process. However, it is an effective entrainer needed in the ED process. The proposed UD is thus more advantageous in terms of safety and health perspectives, with further opportunities to be improved to enhance economic savings with more detailed studies on the use of ultrasonic transducers, both in terms of sizing as well as installation location.

Conclusion

This work has successfully illustrated the potential of sonication phenomena in enhancing the separation process involving azeotropic mixtures. The proposed ultrasonic distillation column has successfully achieved the targeted 99 mol% overhead products for various azeotropic mixtures. This preliminary study on the separation of an ETAC/ETOH mixture has shown the benefits of the proposed system in terms of process economy as well safety perspectives. However, the proposed process is limited only to minimum boiling point azeotropic mixtures. It has nevertheless set a good beginning toward further development of the ultrasonic distillation system.

Acknowledgment

The author is grateful to the University of Babylon. The contribution of the Ministry of Oil, Iraq in providing scholarships for the study is acknowledged.

Author's Contributions

Taha Mahdi: Idea, design, writing the manuscript, simulation and mathematical model. Participated in writing the revising the paper.

Ammar Emad Al-Kawaz: Participated in the idea and writing the revising the paper.

Ethics

This article is original. Author declare that are not ethical issues that may arise after the publication of this manuscript.

References

- Alkhudhiri, A., N. Darwish and N. Hilal, 2012. Membrane distillation: A comprehensive review. *Desalination*, 287: 2-18. DOI: 10.1016/j.desal.2011.08.027
- Apfel, R.E., 1997. Sonic effervescence: A tutorial on acoustic cavitation. *J. Acoust. Society Am.*, 101: 1227-1237. DOI: 10.1121/1.418130

- Ashokkumar, M., J. Lee, S. Kentish and F. Grieser, 2007. Bubbles in an acoustic field: An overview. *Ultras. Sonochem.*, 14: 470-475. DOI: 10.1016/j.ultsonch.2006.09.016
- Ashokkumar, M. and T.J. Mason, 2007. Sonochemistry. *Kirk-othmer encyclopedia of chemical technology*.
- Bono, A., R. Sarbatly, D. Krishnaiah, P.M. San and F.Y. Yan, 2008. Effect of ultrasound on liquid phase adsorption of azeotropic and non-azeotropic mixture. *Catal. Tod.*, 131: 472-476. DOI: 10.1016/j.cattod.2007.10.084
- Chang, H., S.H. Cheng, H.C. Chiang, Y.H. Chen and Y.Y. Chang, 2012. Simulation study of an integrated methanol micro fuel processor and fuel cell system. *Chem. Eng. Sci.*, 74: 27-37. DOI: 10.1016/j.ces.2012.01.043
- Chen, G., R. Shan, J. Shi and B. Yan, 2014. Ultrasonic-assisted production of biodiesel from transesterification of palm oil over ostrich eggshell-derived CaO catalysts. *Bioresource Technol.*, 171: 428-432. DOI: 10.1016/j.biortech.2014.08.102
- Choudhury, H.A., S. Chakma and V.S. Moholkar, 2014. Mechanistic insight into sonochemical biodiesel synthesis using heterogeneous base catalyst. *Ultras. Sonochem.*, 21: 169-181. DOI: 10.1016/j.ultsonch.2013.04.010
- Hosgor, E., T. Kucuk, I.N. Oksal and D.B. Kaymak, 2014. Design and control of distillation processes for methanol-chloroform separation. *Comput. Chem. Eng.*, 67: 166-177. DOI: 10.1016/j.compchemeng.2014.03.026
- Kamihara, Y., T. Watanabe, M. Hirano and H. Hosono, 2008. Iron-based layered superconductor La [O_{1-x}F_x] FeAs (x = 0.05-0.12) with T_c = 26 K. *J. Am. Chem. Society*, 130: 3296-3297. DOI: 10.1021/ja800073m
- Katikaneni, S.P.R. and M. Cheryan, 2002. Purification of fermentation-derived acetic acid by liquid-liquid extraction and esterification. *Indus. Eng. Chem. Res.*, 41: 2745-2752. DOI: 10.1021/ie010825x
- Kirpalani, D. and F. Toll, 2002. Revealing the physicochemical mechanism for ultrasonic separation of alcohol-water mixtures. *J. Chem. Phys.*, 117: 3874-3877. DOI: 10.1063/1.1495849
- Liang, S., Y. Cao, X. Liu, X. Li and Y. Zhao *et al.*, 2017. Insight into pressure-swing distillation from azeotropic phenomenon to dynamic control. *Chem. Eng. Res. Design*, 117: 318-35. DOI: 10.1016/j.cherd.2016.10.040
- Louisnard, O. and J. González-García, 2011. Acoustic Cavitation. In: *Ultrasound Technologies for Food and Bioprocessing*, Feng, H., G. Barbosa-Canovas and J. Weiss (Eds.), Springer, New York, pp: 13-64.
- Mahdi, T., A. Ahmad, A. Ripin and M.M. Nasef, 2015a. State-of-the-art technologies for separation of azeotropic mixtures. *Sep. Purif. Rev.*, 44: 308-330. DOI: 10.1080/15422119.2014.963607
- Mahdi, T., A. Ahmad, A. Ripin, T.A.T. Abdullah and M.M. Nasef *et al.*, 2015b. Mathematical modeling of a single stage ultrasonically assisted distillation process. *Ultras. Sonochem.*, 24: 184-192. DOI: 10.1016/j.ultsonch.2014.11.005
- Mahdi, T., A. Ahmad, A. Ripin and M.M. Nasef, 2014. Vapor-liquid equilibrium of ethanol/ethyl acetate mixture in ultrasonic intensified environment. *Korean J. Chem. Eng.*, 31: 875-880. DOI: 10.1007/s11814-014-0011-9
- Merouan, S., O. Hamdaoui, Y. Rezgui and M. Guemini, 2013. Effects of ultrasound frequency and acoustic amplitude on the size of sonochemically active bubbles-Theoretical study. *Ultras. Sonochem.*, 20: 815-819. DOI: 10.1016/j.ultsonch.2012.10.015
- Modla, G. and P. Lang, 2008. Feasibility of new pressure swing batch distillation methods. *Chem. Eng. Sci.*, 63: 2856-2874. DOI: 10.1016/j.ces.2008.02.034
- Nii, S., K. Matsuura, T. Fukazu, M. Toki and M. Kawaizumi, 2006. A novel method to separate organic compounds through ultrasonic atomization. *Chem. Eng. Res. Design*, 84: 412-415. DOI: 10.1205/cherd05016
- Parkar, P.A., H.A. Choudhary and V.S. Moholkar, 2012. Mechanistic and kinetic investigations in ultrasound assisted acid catalyzed biodiesel synthesis. *Chem. Eng. J.*, 187: 248-260. DOI: 10.1016/j.cej.2012.01.074
- Ripin, A., S.K. Abdul Mudalip, Z. Sukaimi, R.M. Yunus and Z.A. Manan, 2009. Effects of ultrasonic waves on vapor-liquid equilibrium of an azeotropic mixture. *Sep. Sci. Technol.*, 44: 2707-2719. DOI: 10.1080/01496390903014474
- Sulaiman, A.Z., A. Ajit, R.M. Yunus and Y. Chisti, 2011. Ultrasound-assisted fermentation enhances bioethanol productivity. *Biochem. Eng. J.*, 54: 141-150. DOI: 10.1016/j.bej.2011.01.006
- Suzuki, K., K. Arashi and S. Nii, 2012. Determination of droplet and vapor ratio of ultrasonically-atomized aqueous ethanol solution. *J. Chem. Eng. Jpn.*, 45: 337-342. DOI: 10.1252/jcej.11we196
- Towler, G.P. and R.K. Sinnott, 2013. *Chemical Engineering Design: Principles, Practice and Economics of Plant and Process Design*. 2nd Edn., Elsevier, ISBN-10: 0080966608, pp: 1320.
- Wisniak, J., L. Aharon, Y. Nagar, H. Segura and R. Reich, 2001. Effect of pressure on the vapor-liquid equilibria of the system methanol + ethyl 1,1-dimethylethyl ether. *Phys. Chem. Liq.*, 39: 723-737. DOI: 10.1080/00319100108031688
- Zhang, Z.G., M. Lv, L.F. Chen and W.X. Li, 2012. Organic solvents for separating ethyl acetate-ethanol by extractive distillation. *Adv. Mater. Res.*, 550-553: 699-703. DOI: 10.4028/www.scientific.net/AMR.550-553.699